

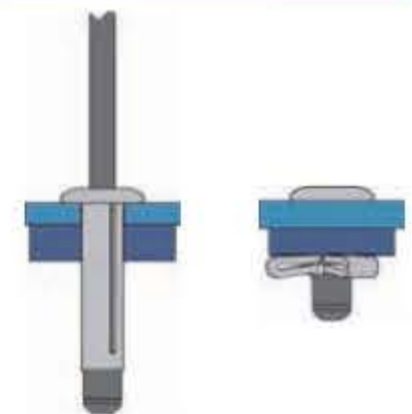

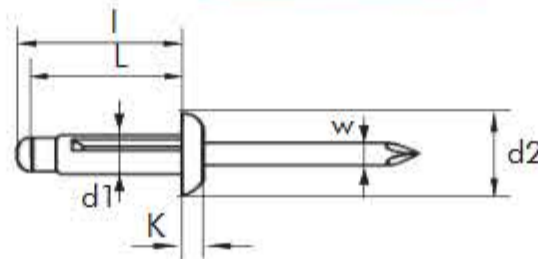

TREBOL RIVET
Dome head

ALUMINIUM/ALUMINIUM



BODY: Aluminium
MANDREL: Aluminium

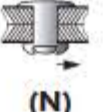

d1 Ø mm	L Nominal mm		d2 Ø mm	K mm	W Ø mm	PACKAGING		I Max. mm	E mm				REFERENCE
						Inner	Outer		MIN.	MAX.			
4,0	10,5	4,20-4,50	8,00	1,40	2,40	250	2.000	12,30	0,5 - 2,5	730	950		01610004010
	13,6					250	2.000	15,40	1,0 - 3,0				01610004013
	18,8					250	2.000	20,60	1,0 - 7,0				01610004018
	20,4					250	1.500	22,20	1,0 - 8,5				01610004020
	24,5					250	1.500	26,30	4,0 - 12,0				01610004024
4,8	15,3	5,00-5,30	10,00	1,90	2,82	250	2.000	16,70	1,0 - 4,0	900	1150		01610004815
	20,5					250	1.500	21,90	1,0 - 9,0				01610004820
	24,5					200	1.200	25,90	4,0 - 12,0				01610004824
	28,0					200	1.200	29,40	6,0 - 16,0				01610004828

Tests according to EN ISO 14589

Note: Under request we do manufacture Trebol rivets with countersunk head (d2).



d1 Ø mm	L Nominal mm	PAINTED WHITE		PAINTED BLACK RAL 9005		REST OF THE PAINTED COLOURS		PACKAGING	
		REFERENCE	REFERENCE	REFERENCE	Inner	Outer			
4,0	10,5	01610 BL4010	01610 N04010	01610 4010	250	2.000			
	13,6	01610 BL4013	01610 N04013	01610 4013	250	2.000			
	18,8	01610 BL4018	01610 N04018	01610 4018	250	2.000			
	24,5	01610 BL4024	01610 N04024	01610 4024	250	1.500			
4,8	15,3	01610 BL4815	01610 N04815	01610 4815	250	2.000			
	20,5	01610 BL4820	01610 N04820	01610 4820	250	1.500			
	24,5	01610 BL4824	01610 N04824	01610 4824	200	1.200			

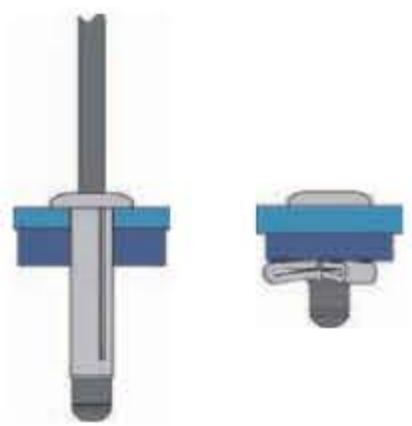

ALUMINIUM/ALUMINIUM

TREBOL RIVET
Large head

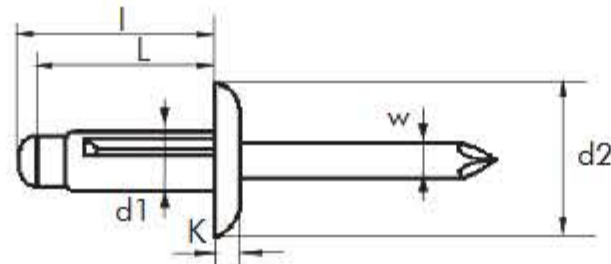

BODY: Aluminium
MANDREL: Aluminium



d1 Ø mm	L Nominal mm		d2 Ø mm	K mm	W Ø mm	PACKAGING		I Max. mm	E mm				REFERENCE
						Inner	Outer		MIN.	MAX.			
4,0	18,8	4,20-4,50	12,00	1,50	2,40	250	2.000	20,60	1,0 - 7,0	700	850		01640004018
4,8	20,5	5,00-5,30	14,00	1,90	2,82	200	1.200	21,90	1,0 - 9,0	900	1150		01630004820
	24,5					200	1.200	25,90	4,0 - 12,0				01630004824
4,8	20,5	5,00-5,30	16,00	1,80	2,82	200	1.200	21,90	1,0 - 9,0	900	1150		G1640004820

Tests according to EN ISO 14589

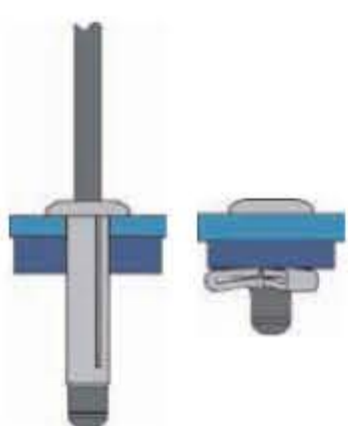

ALUMINIUM/ALUMINIUM

S-TREBOL RIVET
Dome head

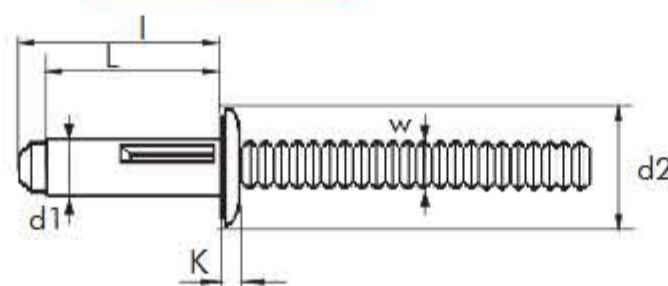

BODY: Aluminium
MANDREL: Aluminium



d1 Ø mm	L Nominal mm		d2 Ø mm	K mm	W Ø mm	PACKAGING		I Max. mm	E mm				REFERENCE
						Inner	Outer		MIN.	MAX.			
5,2	20,0*	5,30-5,60	11,40	2,00	3,10	250	1.500	23,75	0,5 - 5,1	3000	1700		01650005220
	26,5					200	1.200	29,75	4,5 - 11,5				01650005226
6,4	23,5	6,50-6,70	14,00	2,60	3,40	150	900	28,50	1,5 - 6,5	4000	2500		01650006424
7,7	28,0	7,90-8,30	19,00	4,00	4,40		500	35,00	1,5 - 9,5	4300	4800		G1654007828
	34,0								6,5 - 15,9				G1654007834

Tests according to EN ISO 14589

* Approved by DIBt (Deutsches Institut für Bautechnik) N Z-14. 1-4.

Note: Also available without neoprene washer.

