



# N2 Compression Latch

Lift & turn series · Folding T-handle · Flush cup style · Adjustable grip

- Heavy-duty performance
- Flush profile when latched
- Easy grip adjustment
- Intuitive operation

### Material and Finish

Black powder coat version:  
 Handle: Aluminum, Zinc Alloy  
 Cup and hardware: Steel  
 Stainless Steel version:  
 Handle, cup and hardware: Stainless steel

### Performance Details

Maximum static load:  
 1000 N (225 lbf)  
 Compression: 6.4 mm (.25 in)

### Installation Notes

1. Insert latch and tighten 4 mounting nuts.
2. With latch in closed position, adjust jam nuts to position cam at correct grip.  
 Maximum tightening torque: 20 N·m (177 in·lbf)

### Keys

See page 121

### Part Number Selection

See table  
 For Standard and Medium cup,  
 Order both parts separately

Choose latch body style

Choose cam (see table)

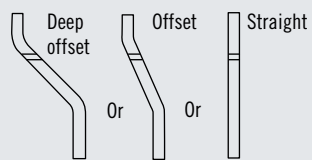

Large cup comes standard with cam part number 62-0-40145

### Standard Locking Cup Shown

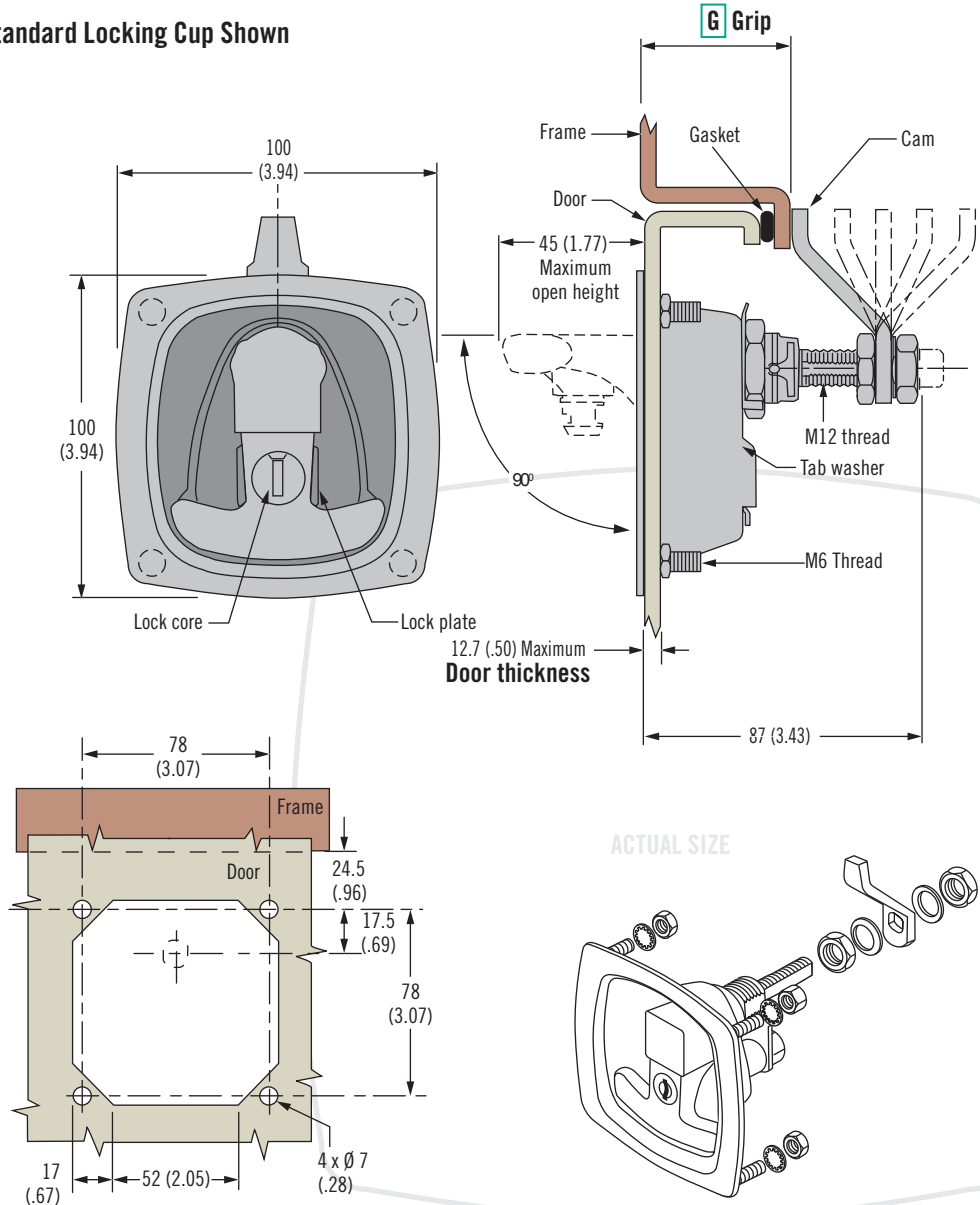

### Latch part number (no cam)

**N2 - 2 - C 0 L - 01 - F**

- C** Cup style
  - 3 Standard cup
  - 5 Medium cup
  - 7 Large cup
- L** Locking style
  - 0 Non-locking
  - 1 Key-locking keyed alike CH751 (2 keys supplied)
- F** Finish
  - 5 Black powder coated
  - 20 Polished stainless

Cam Part Number Table (order separately)				
Part Number		G Grip		Cam Type
Steel	Stainless Steel	Minimum	Maximum	
N2-21-101-12	N2-21-101-24	28 (1.10)	43 (1.69)	Deep offset cam, forward
		88 (3.46)	104 (4.09)	Deep offset cam, reversed
N2-21-102-12	N2-21-102-24	43 (1.69)	58 (2.28)	Offset cam, forward
		73 (2.87)	88 (3.46)	Offset cam, reversed
N2-21-103-12	N2-21-103-24	58 (2.28)	73 (2.87)	Straight



# N2 Compression Latch

Lift & turn series · Folding T-handle · No cup style · Adjustable grip

## Locking Shown

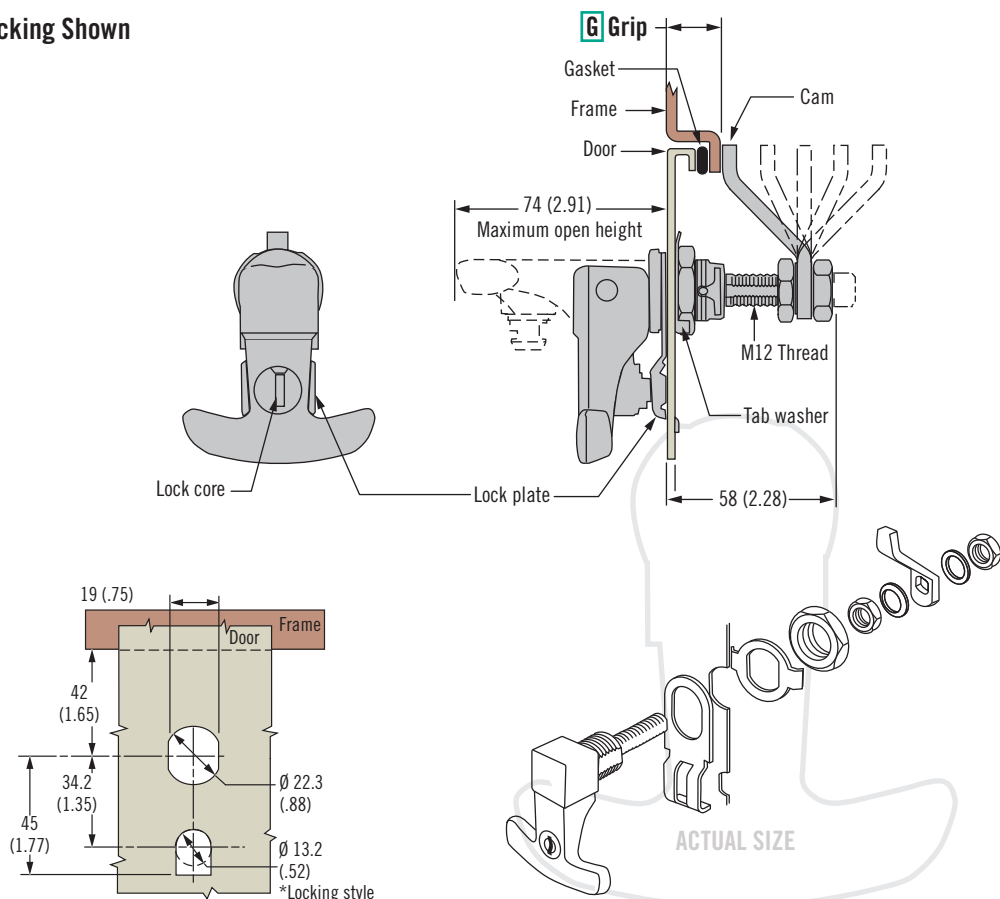

- Heavy-duty performance
- Low profile when latched
- Easy grip adjustment
- Intuitive operation

## Material and Finish

Black powder coat version:  
 Handle: Aluminum, Zinc Alloy  
 Hardware: Steel  
 Stainless Steel version:  
 Handle and hardware:  
 Stainless steel

## Performance Details

Maximum static load:  
 1000 N (225 lbf)  
 Compression: 6.4 mm (.25 in)

## Installation Notes

1. Insert latch and tighten mounting nut.
2. Bend tab washer over mounting nut.
3. With latch in closed position, adjust jam nuts to position cam at correct grip. Maximum tightening torque: 20 N·m (177 in·lbf)

## Keys

See page 121

Order both parts separately

Choose latch body style

Choose cam (see table)

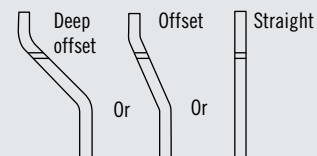

## Part Number Selection

See table

**F** Finish  
 5 Black powder coated  
 20 Polished stainless

**L** Locking style  
 0 Non-locking  
 1 Key-locking keyed alike  
 CH751 (2 keys supplied)

Latch part number  
 (no cam)

**N2 - 2 - 10 L - 01 - F**

Cam Part Number Table (order separately)				
Part Number		Grip		Cam Type
Steel	Stainless Steel	Minimum	Maximum	
N2-21-101-12	N2-21-101-24	2.5 (.10)	15 (.59)	Deep offset cam, forward
		60 (2.36)	75 (2.95)	Deep offset cam, reversed
N2-21-102-12	N2-21-102-24	15 (.59)	30 (1.18)	Offset cam, forward
		45 (1.77)	60 (2.36)	Offset cam, reversed
N2-21-103-12	N2-21-103-24	30 (1.18)	45 (1.77)	Straight

## N2 Product Family

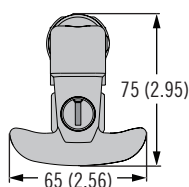

No Cup Style

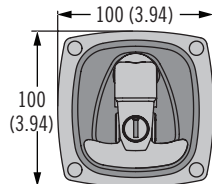

Standard Cup

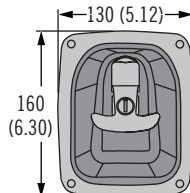

Medium Cup

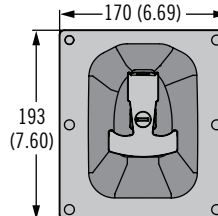

Large Cup



Dimensions in millimeters (inch) unless otherwise stated

[www.southco.com/N2](http://www.southco.com/N2)

## Notes

Other styles available  
 Custom colors and keycodes  
 Contact Southco for details